

FIRST FLOOR PLAN 4-1 "C"

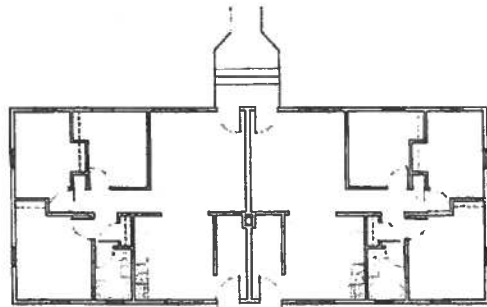

FIRST FLOOR PLAN 4-1 "G"

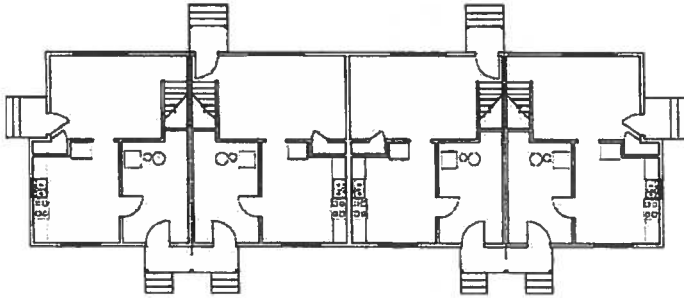

FIRST FLOOR PLAN 4-1 "A"

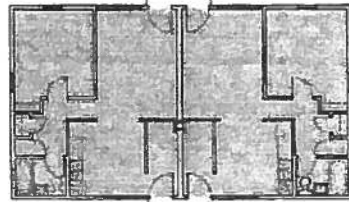

SECOND FLOOR PLAN 4-2 "G"

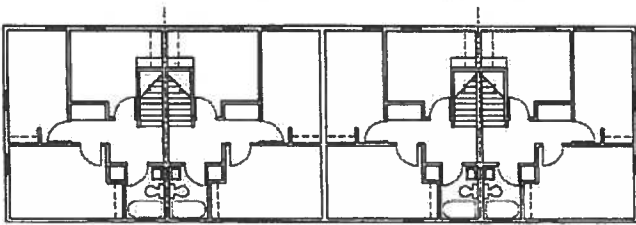

FIRST FLOOR PLAN 4-2 "E"

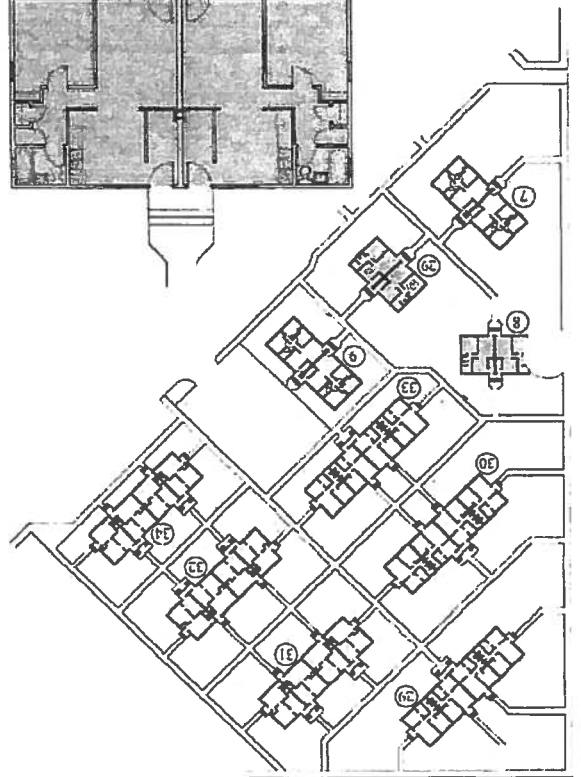
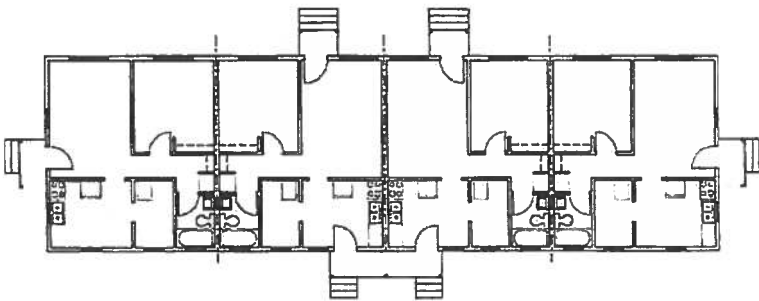

MT004001 S.01

Quadrant A

Site Plan 4-1 and 4-2 Projects

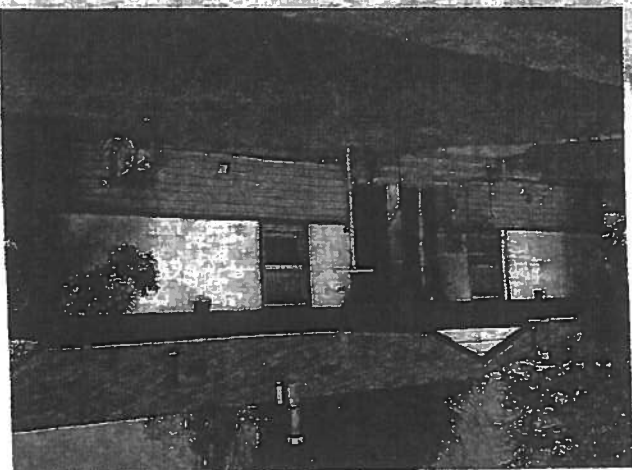
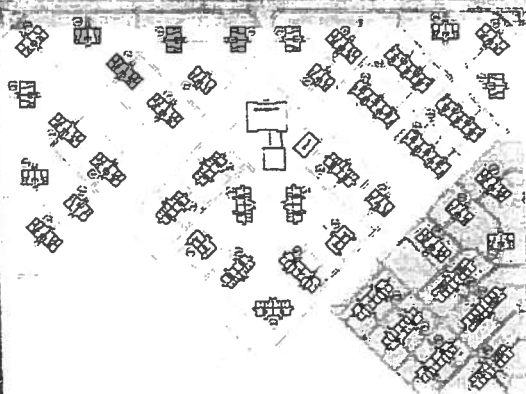

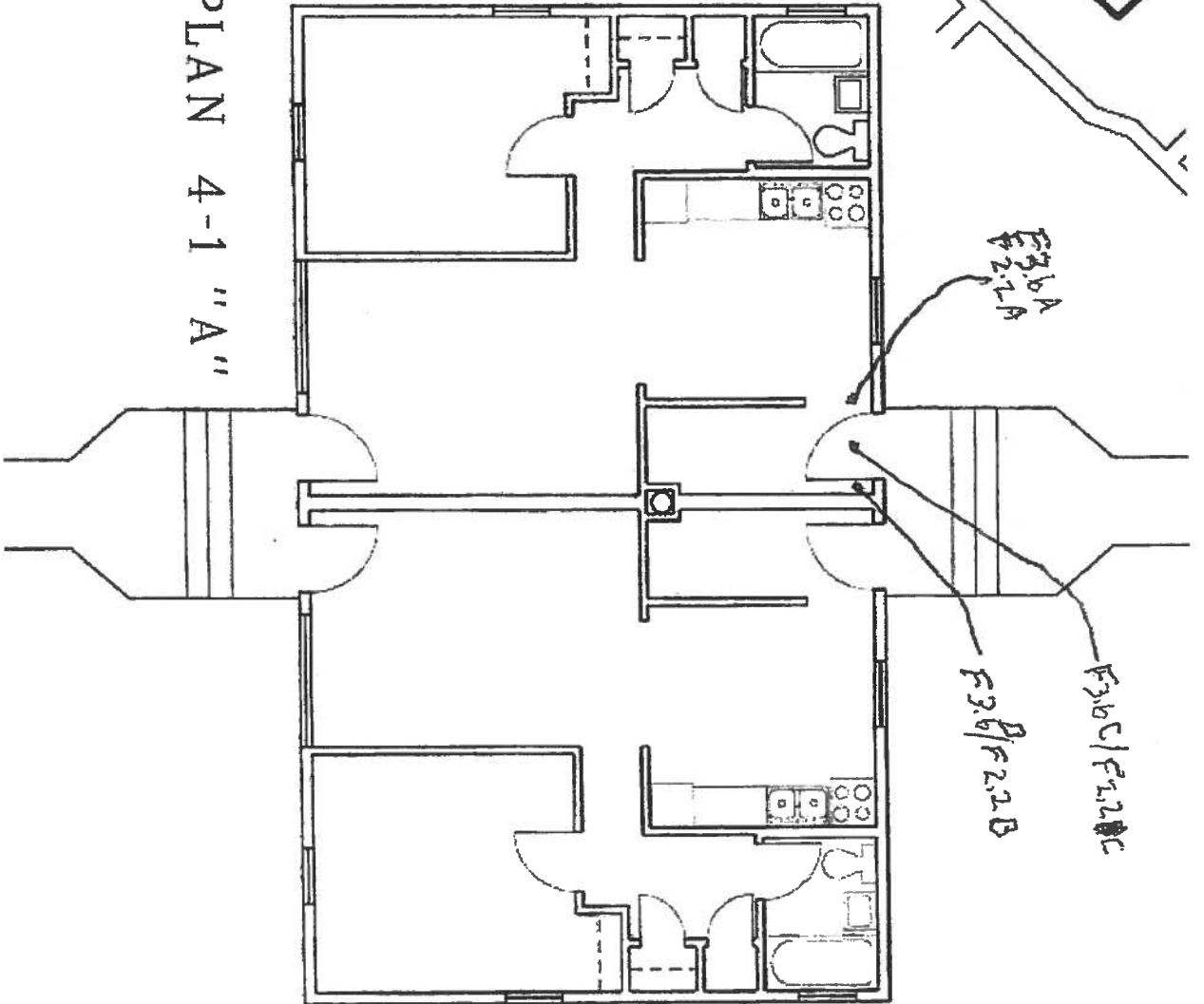
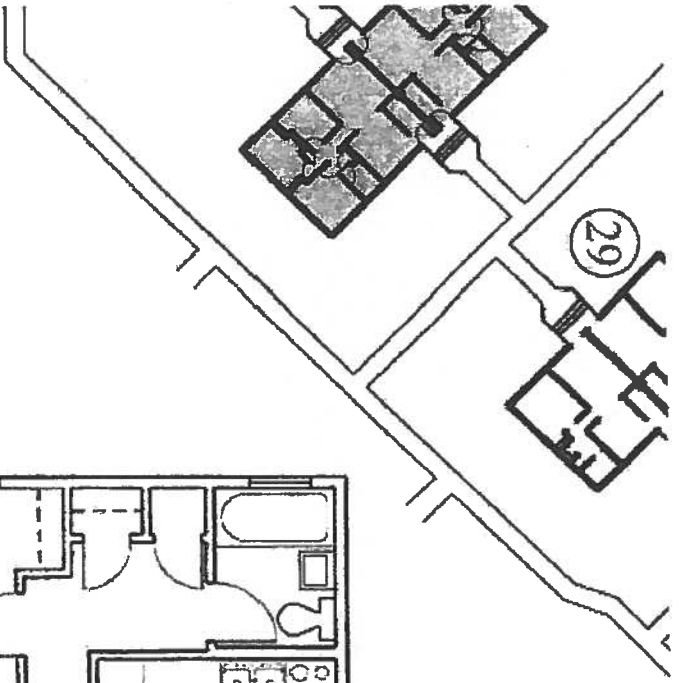

FIRST FLOOR PLAN 4-1 "A"

FIRST FLOOR PLAN 4-1 "C"

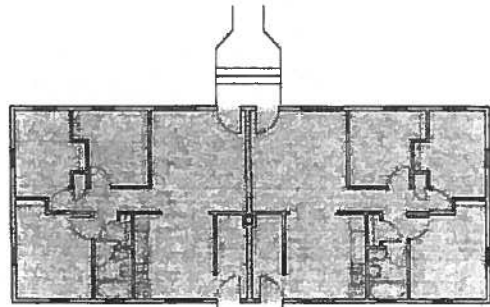

FIRST FLOOR PLAN 4-1 "B"

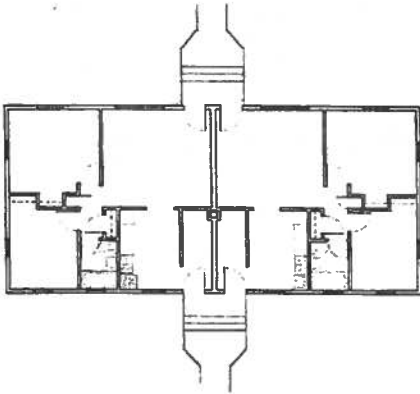

FIRST FLOOR PLAN 4-1 "A"

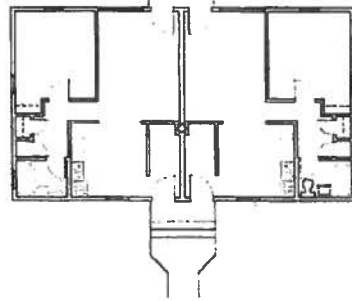

FIRST FLOOR PLAN 4-1 "D"

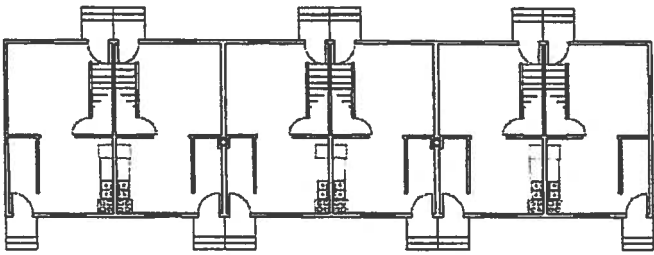

SECOND FLOOR PLAN 4-1 "D"

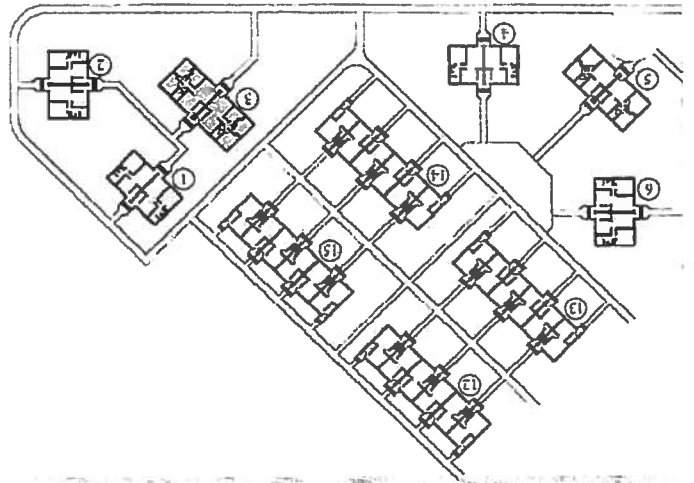
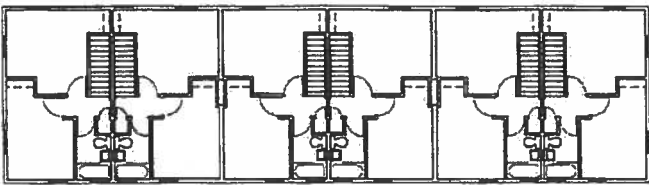

MT004001 S 01

Quadrant B

SEE PLAN 4-1 AND 4-2 PROJECTS

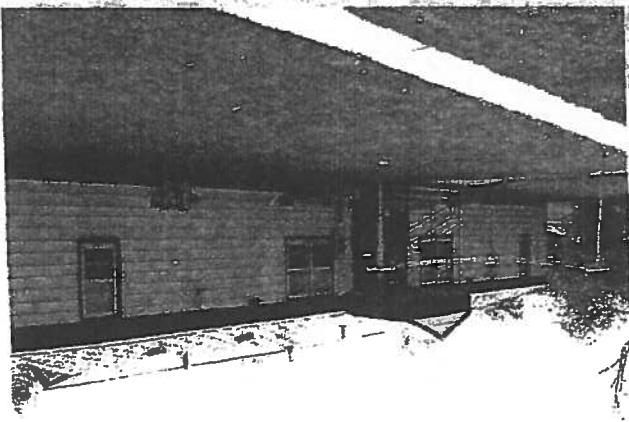

FIRST FLOOR PLAN 4-1 "A"

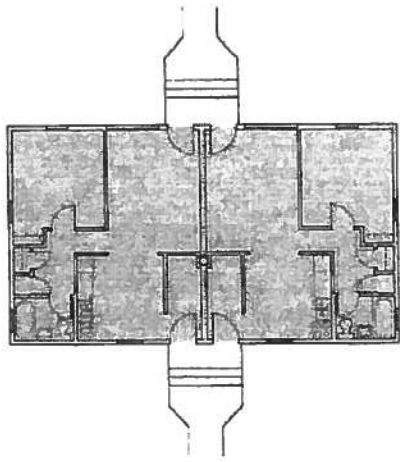

MAIN FLOOR PLAN

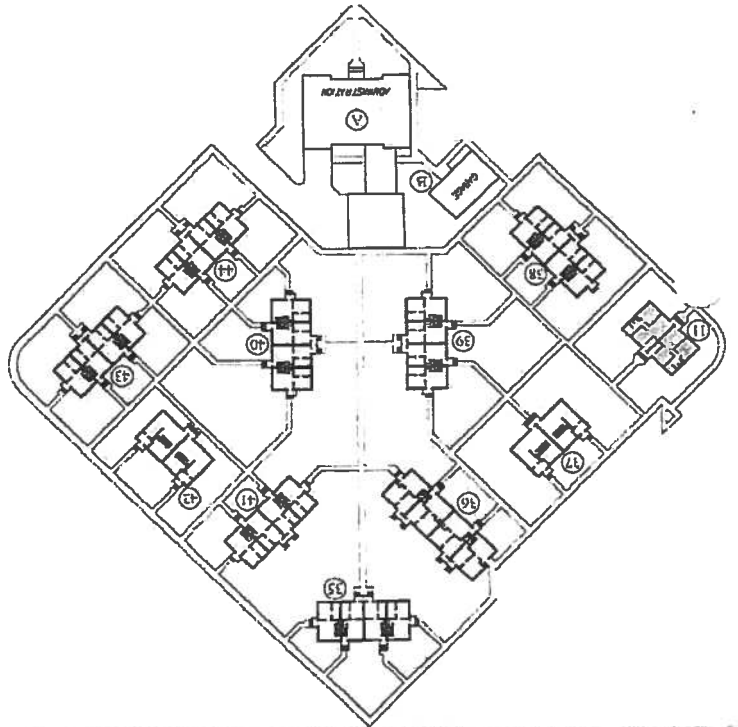
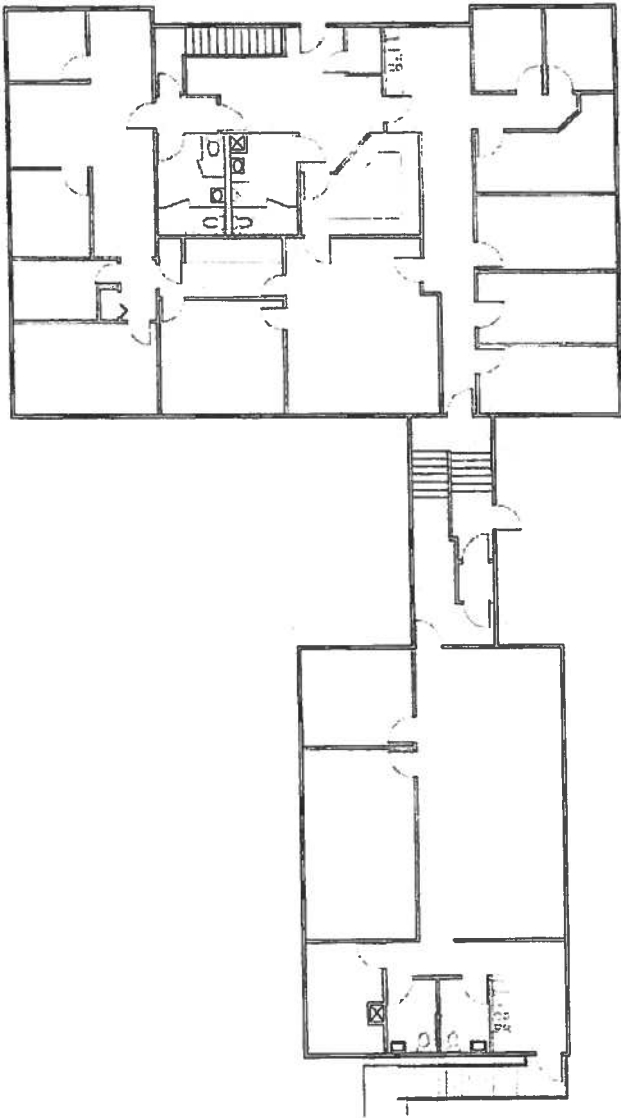

MT004001 S.01 Quadrant D

SITE PLAN 4-1 AND 4-2 PROJECTS

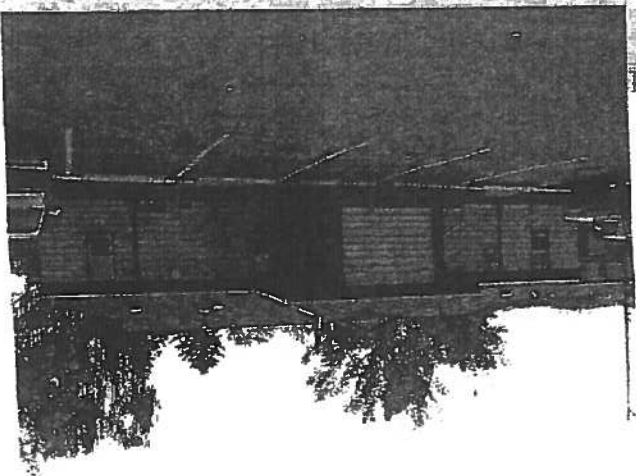
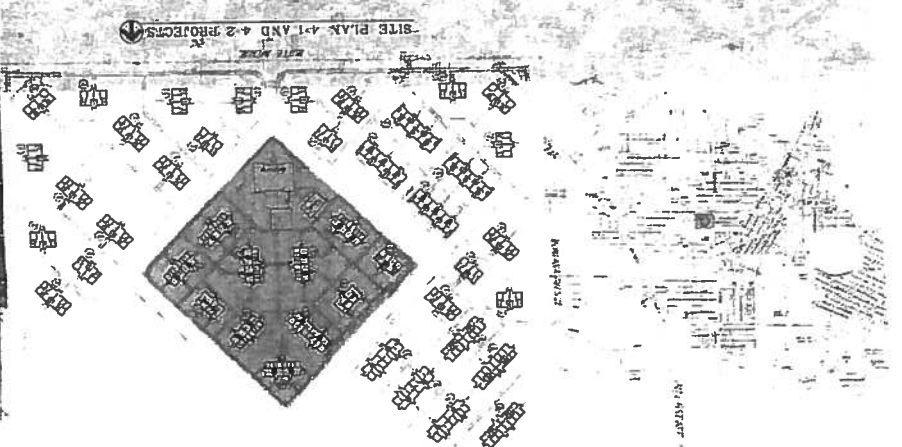

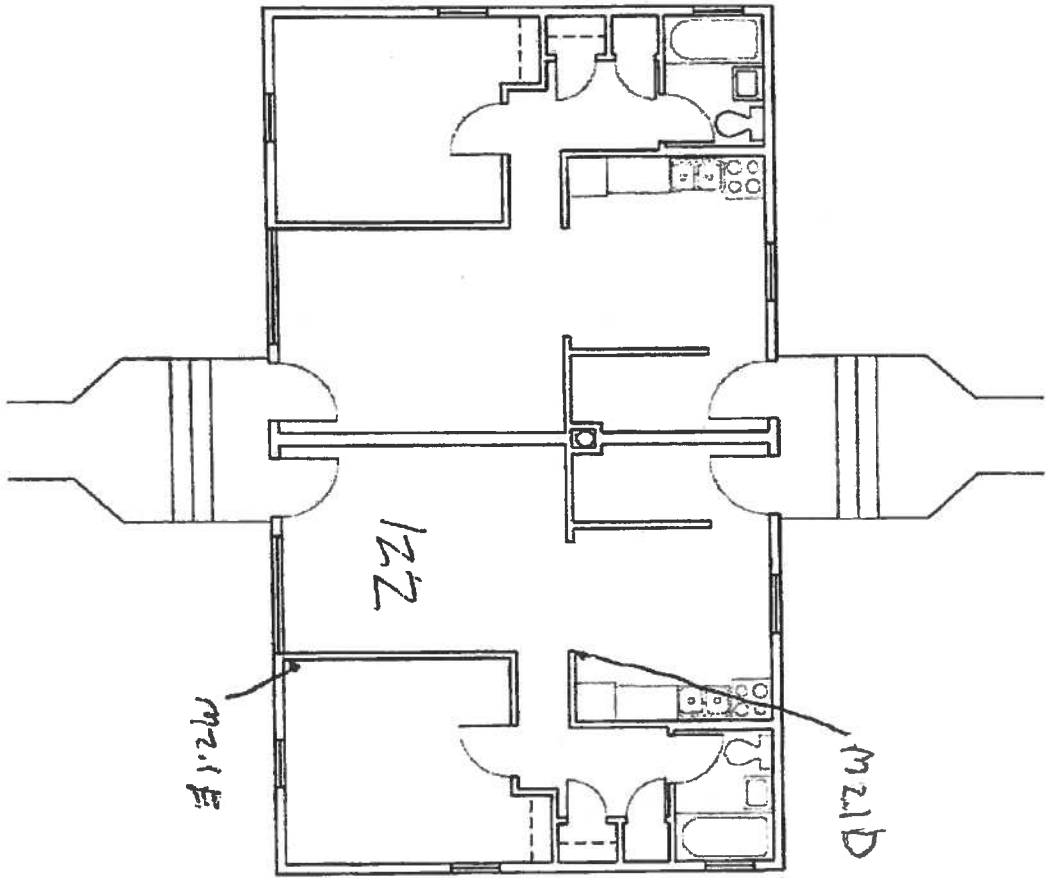

FIRST FLOOR PLAN 4-1 "A"

122

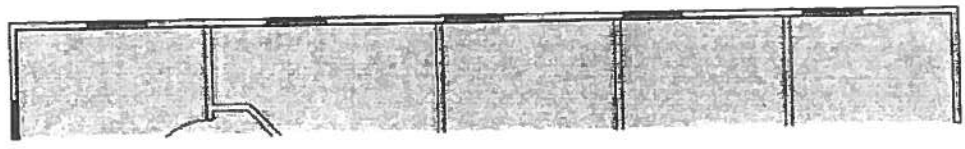

FIRST FLOOR PLAN 4-1 "C"

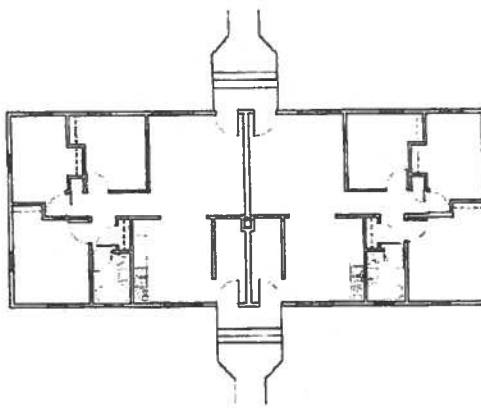

FIRST FLOOR PLAN 4-1 "B"

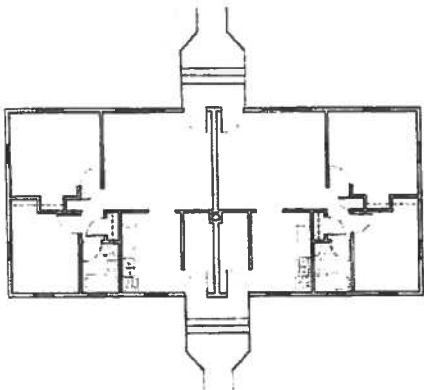

FIRST FLOOR PLAN 4-1 "A"

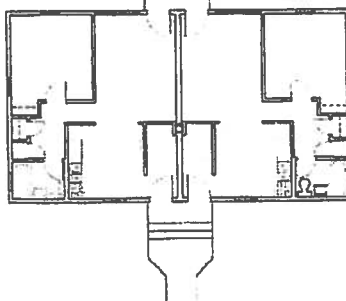

FIRST FLOOR PLAN 4-1 "D"

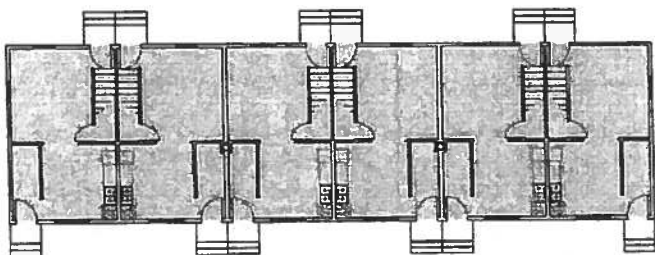

SECOND FLOOR PLAN 4-1 "D"

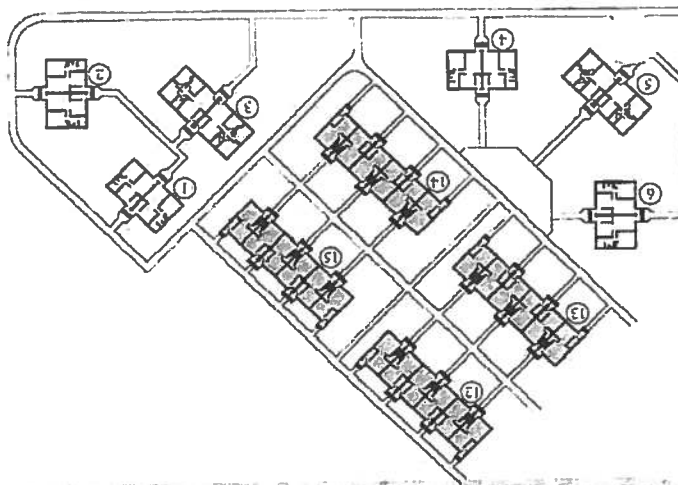
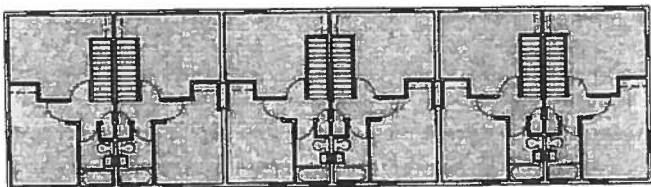

MT004001 S.01 Quadrant B

SITE PLAN 4-1 AND 4-2 PROJECTS

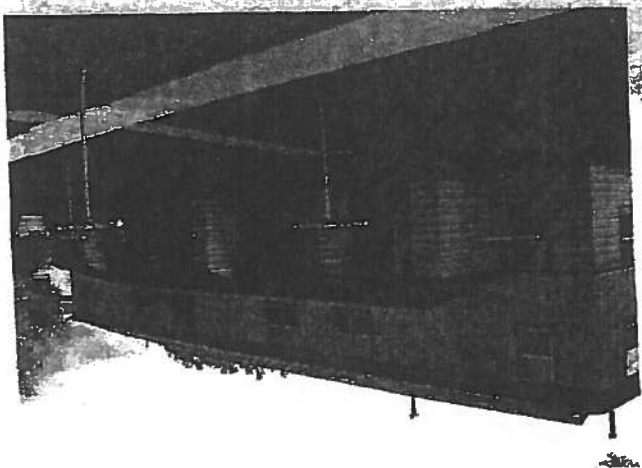

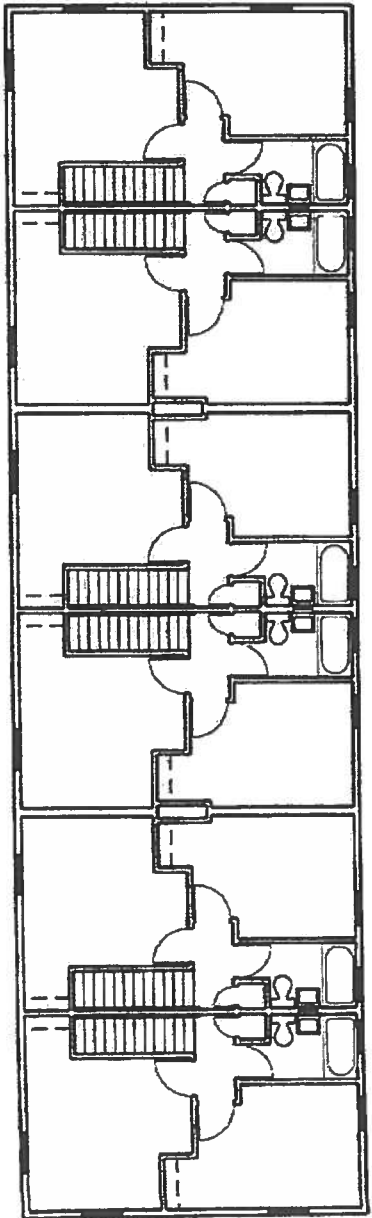
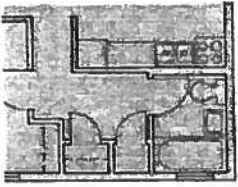
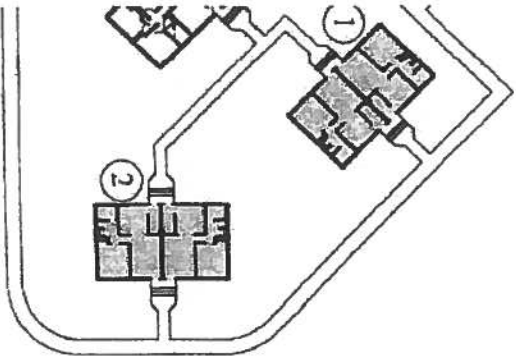

SECOND FLOOR PLAN 4-1 "D"

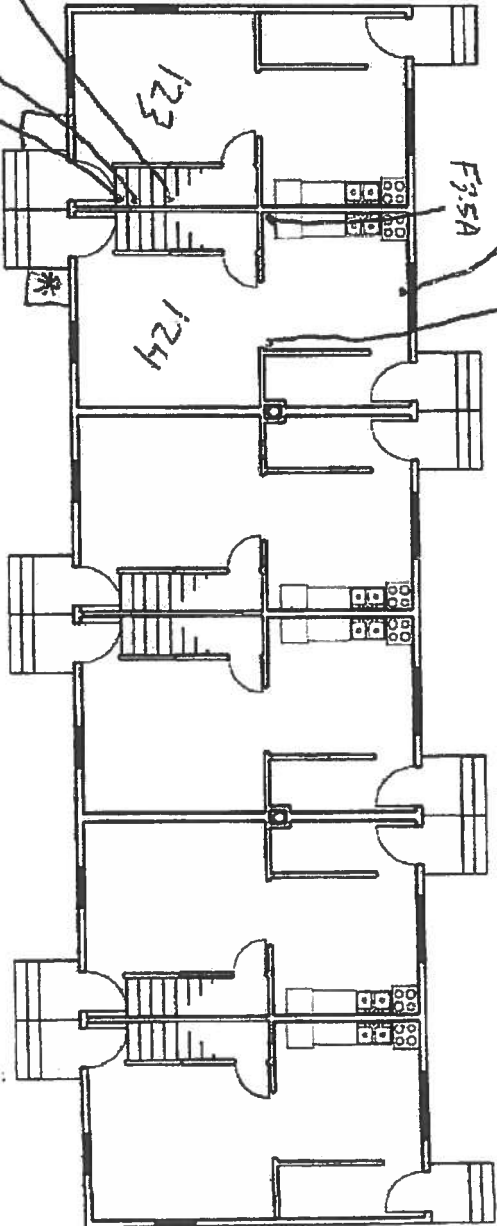

FIRST FLOOR PLAN 4-1 "D"

123, 124

Floorplan 4-1 "D" * Exposed wood components on exterior steps attached storage closets ~~are~~ have paint in poor and deteriorated condition - should be tested for lead-based paint - Per Matt LBP has been addressed

FIRST FLOOR PLAN 4-1 "B"

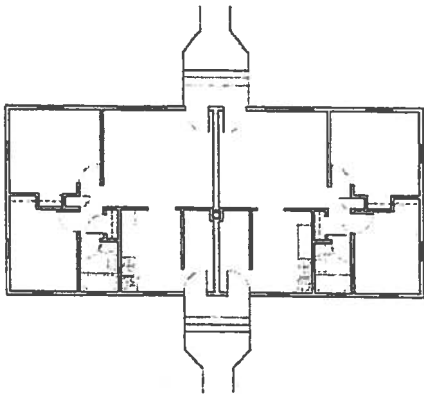

FIRST FLOOR PLAN 4-1 "C"

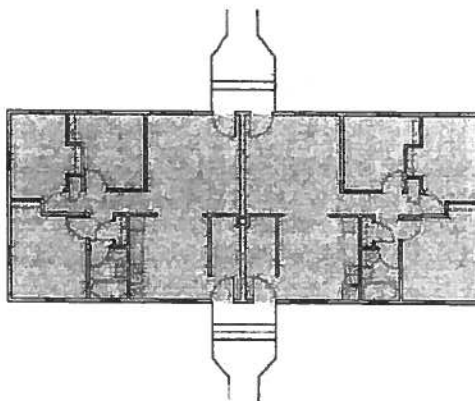

FIRST FLOOR PLAN 4-1 "A"

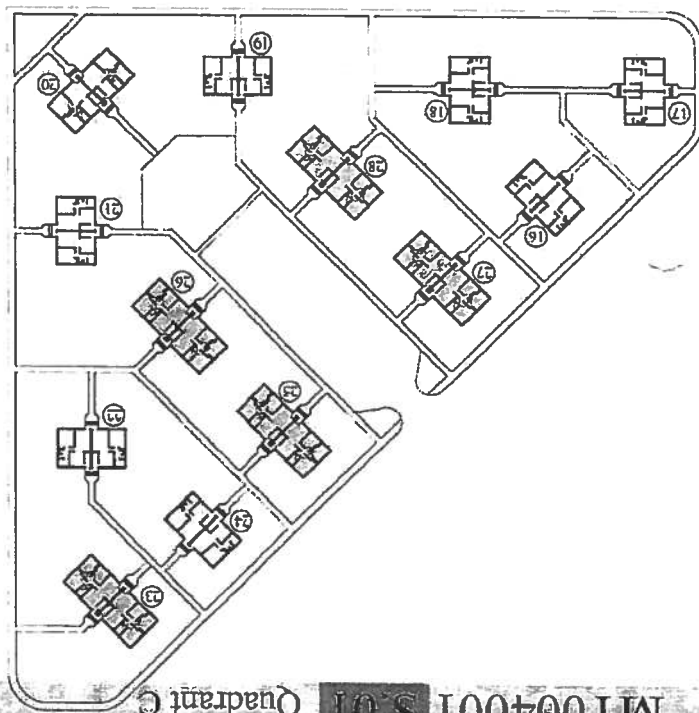
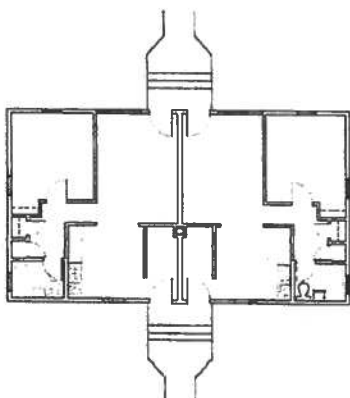

MT004001 S 01 Quadrant C

SITE PLAN 4-1 AND 4-2 PROJECTIONS

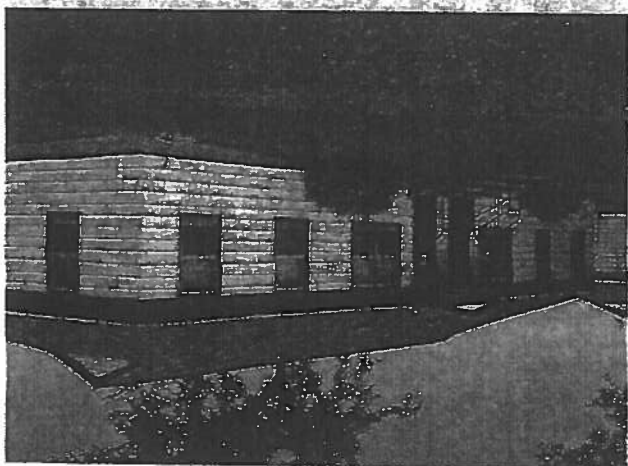

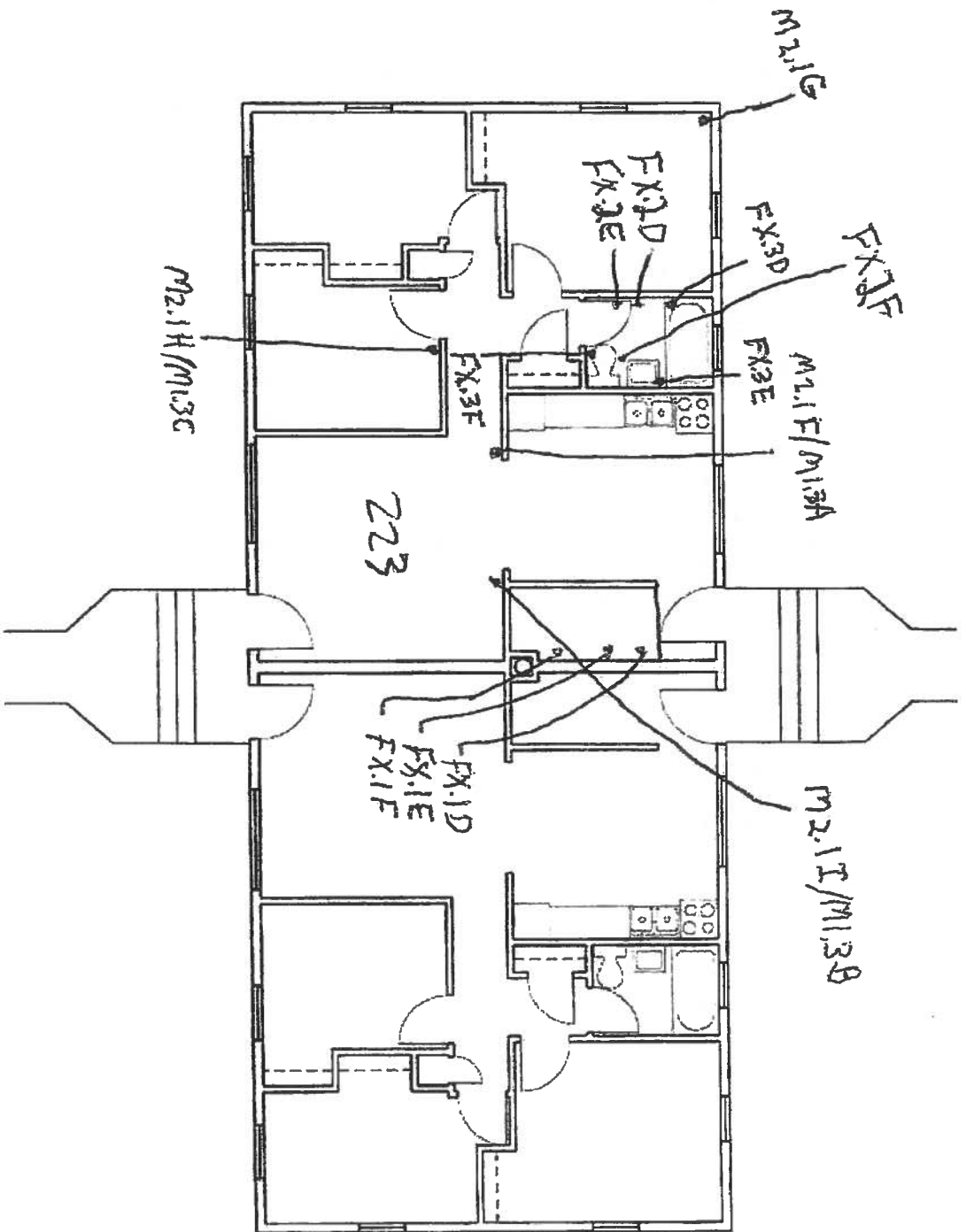

FIRST FLOOR PLAN 4-1 "C"

223

FIRST FLOOR PLAN 4-1 "C"

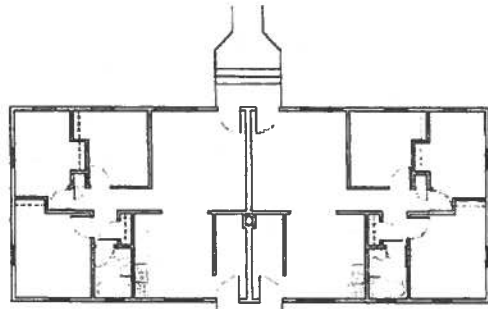

FIRST FLOOR PLAN 4-1 "G"

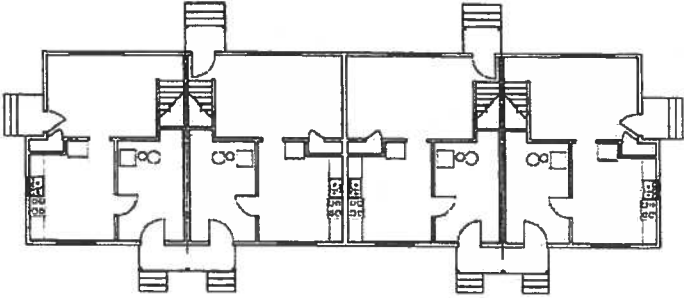

FIRST FLOOR PLAN 4-1 "A"

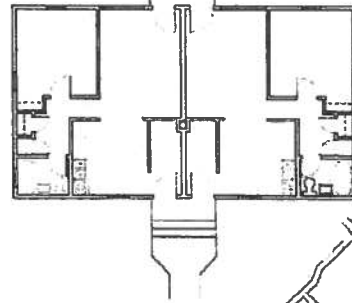

SECOND FLOOR PLAN 4-2 "G"

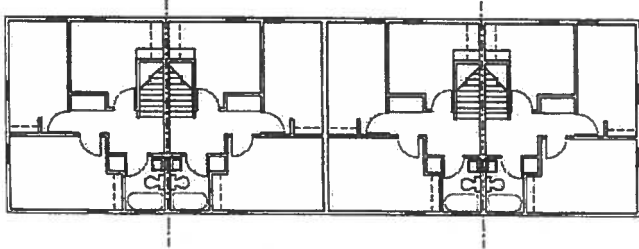

FIRST FLOOR PLAN 4-2 "E"

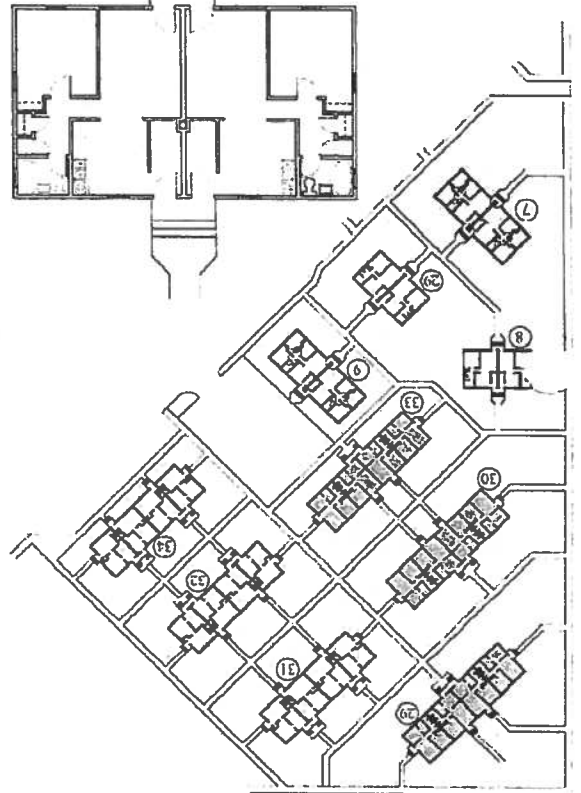
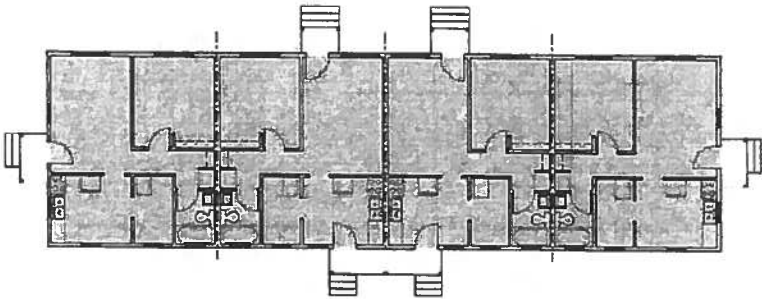

MT004002 S 01 Quadrant A

SITE PLAN 4-1 AND 4-2 PROJECTS



306

FIRST FLOOR PLAN 4-2 "E"

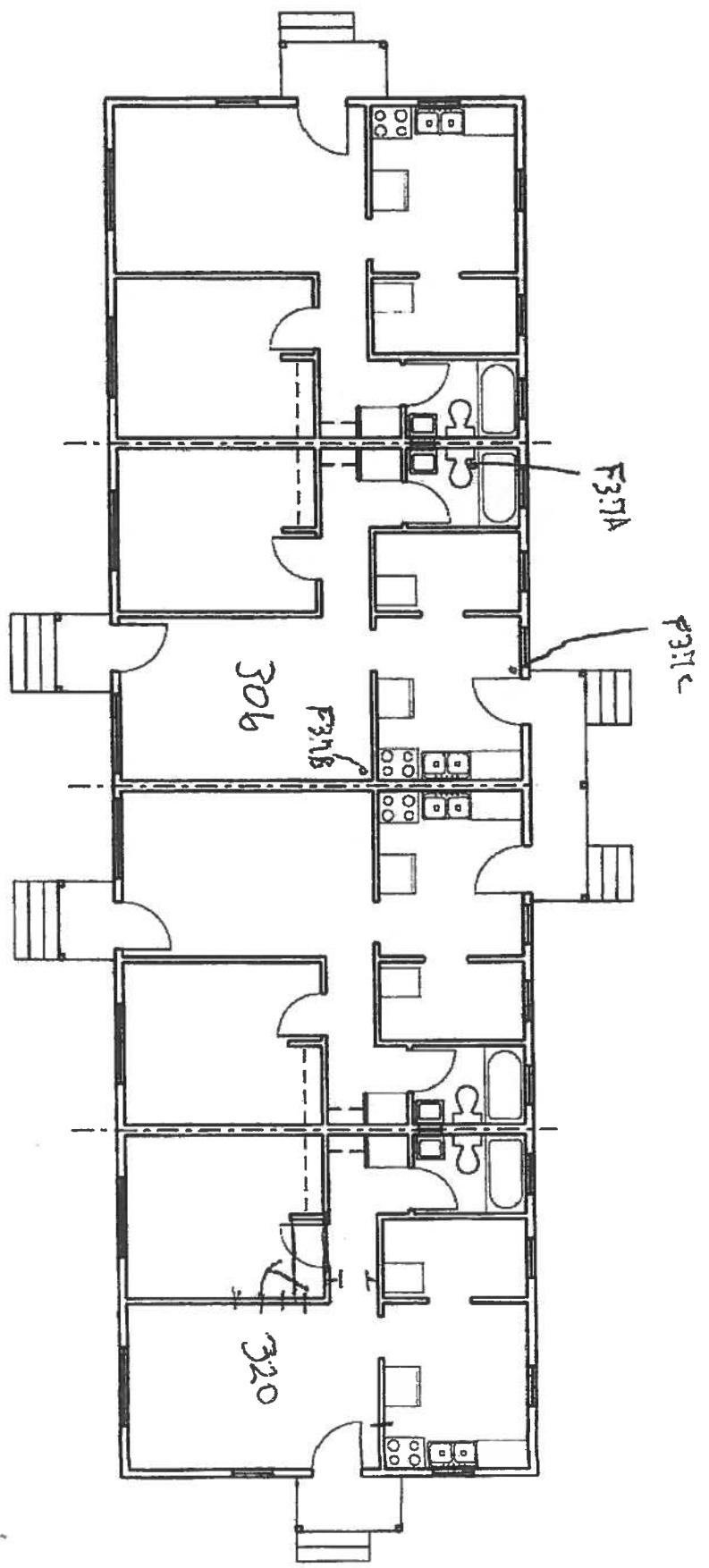

FIRST FLOOR PLAN 4-2 "F"

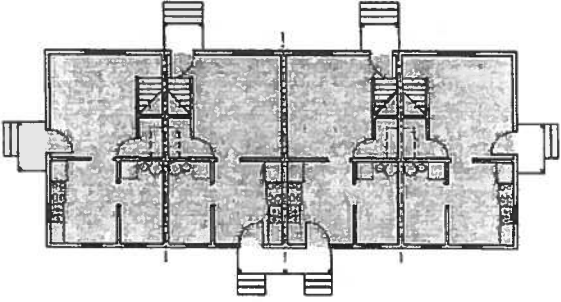

SECOND FLOOR PLAN 4-2 "F"

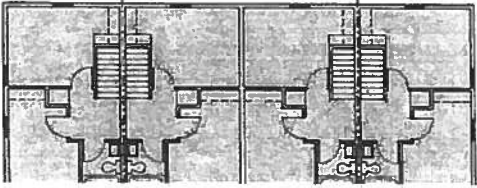

FIRST FLOOR PLAN 4-1 "G"

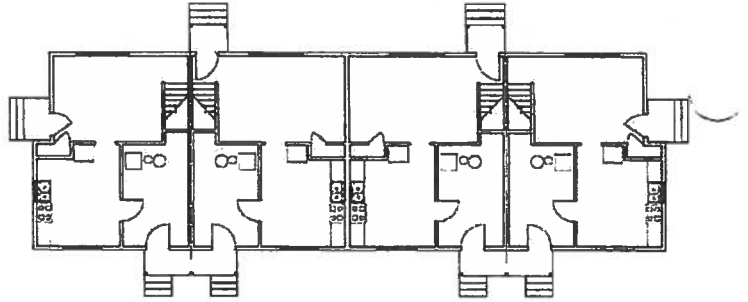

SECOND FLOOR PLAN 4-2 "G"

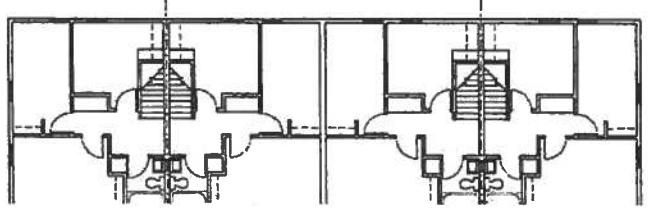

FIRST FLOOR PLAN 4-1 "H"

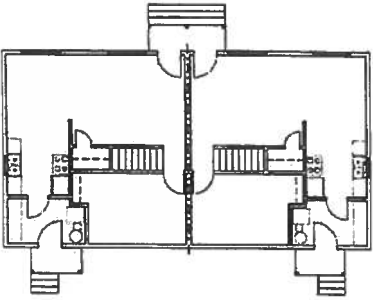

SECOND FLOOR PLAN 4-2 "H"

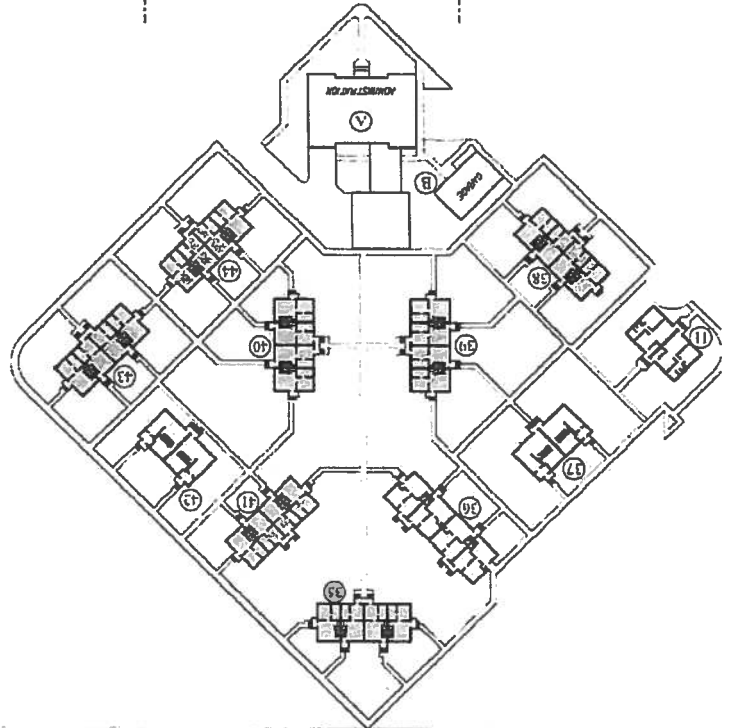
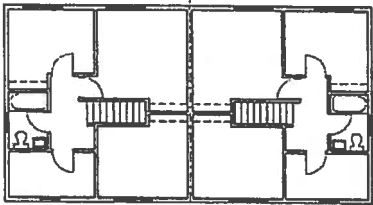

MT004002 S.01 Quadrant D

SITE PLAN 4-1 AND 4-2 PROJECTS

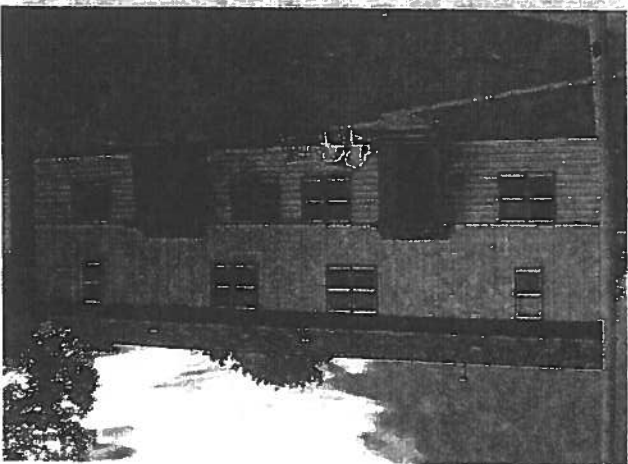
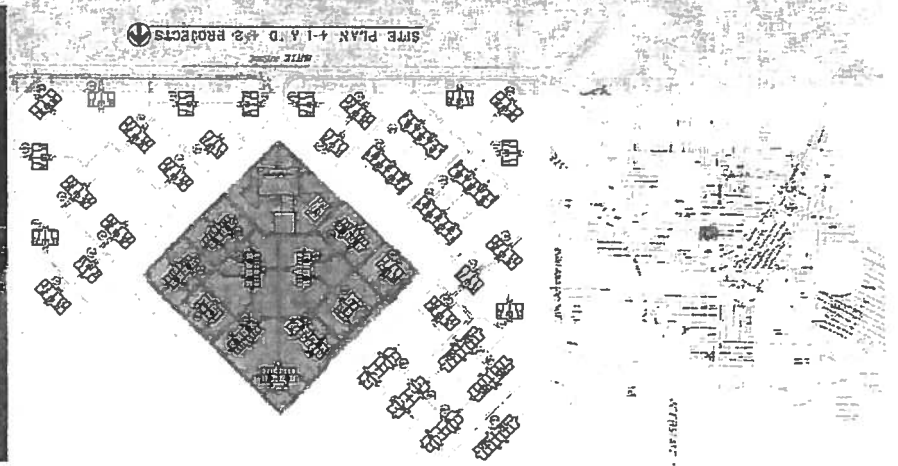

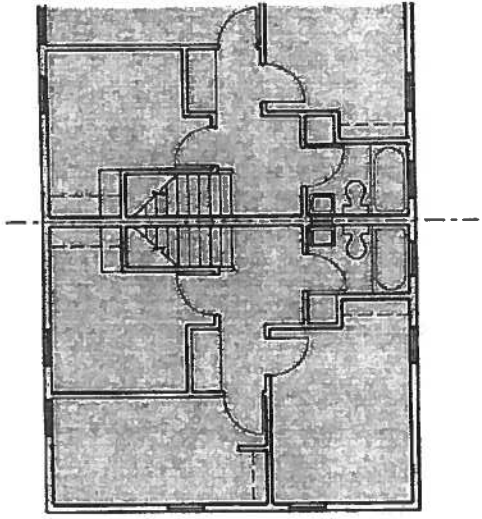

2 "G"

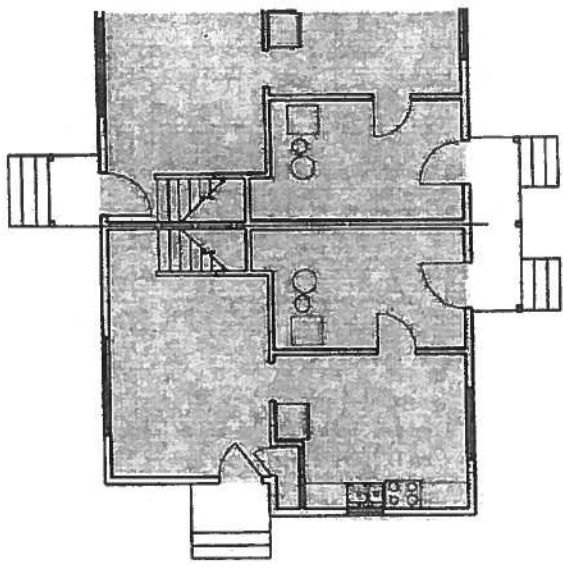

N 4-1 "G"

402

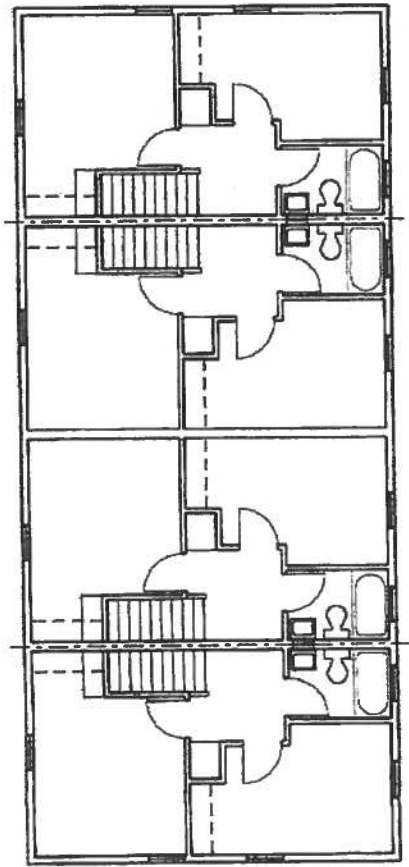

SECOND FLOOR PLAN 4-2 "F"

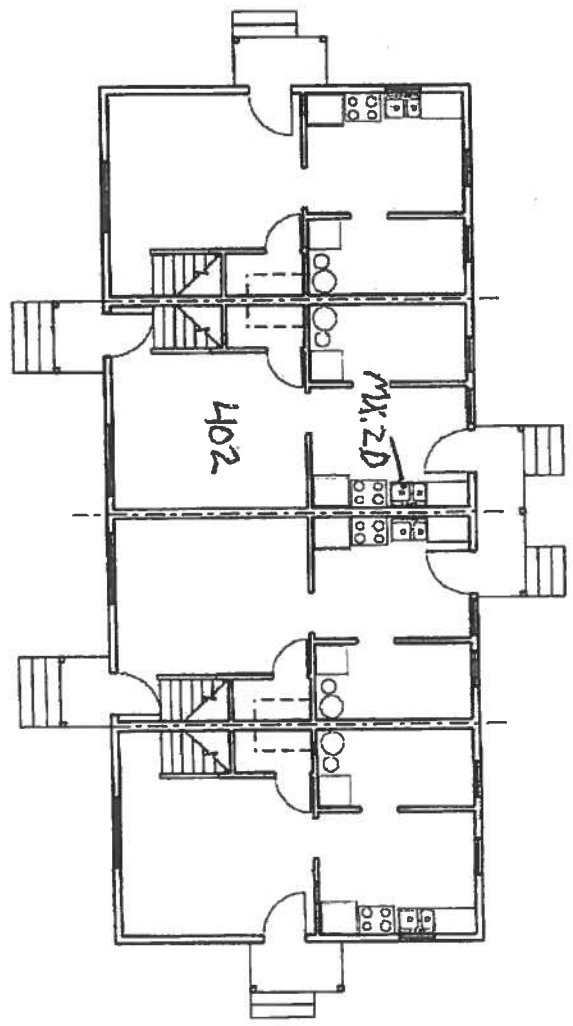

FIRST FLOOR PLAN 4-2 "F"

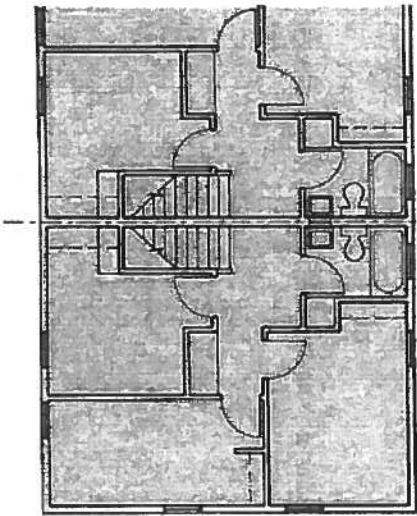

2 "G"

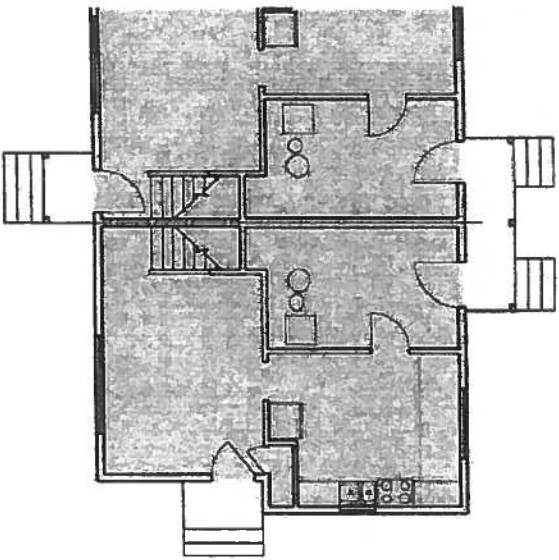

N 4-1 "G"

418

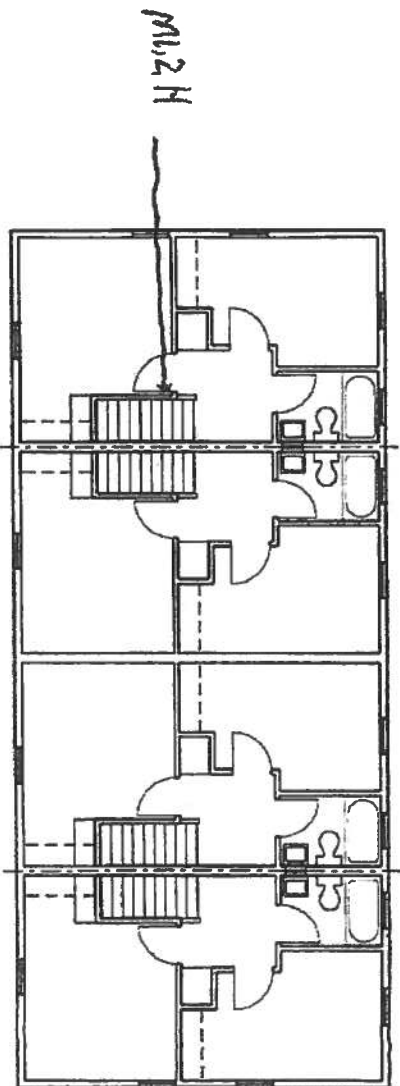

SECOND FLOOR PLAN 4-2 "F"

M1.2H

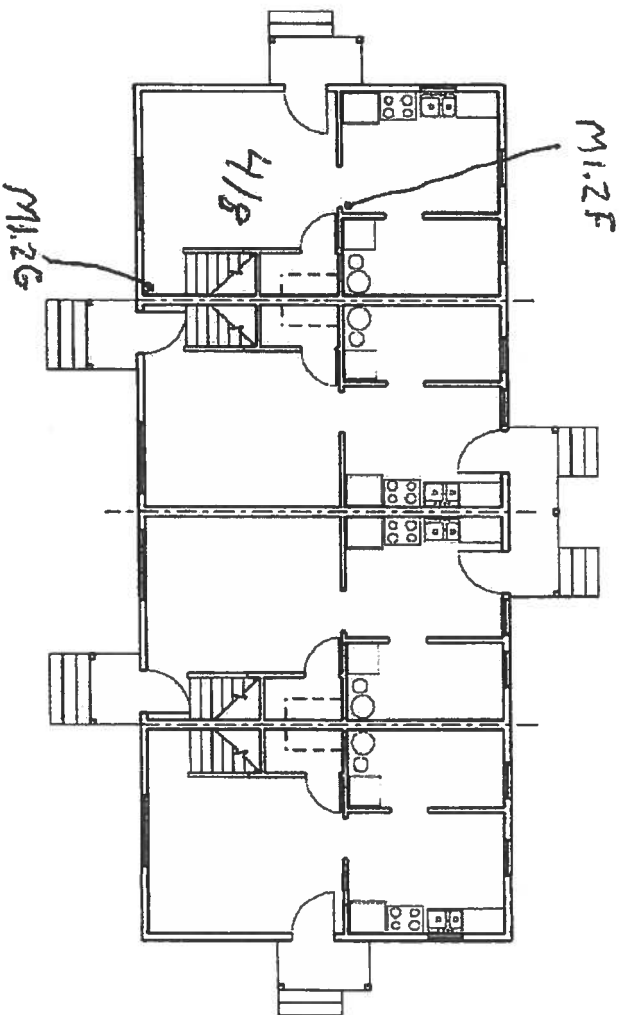

FIRST FLOOR PLAN 4-2 "F"

M1.2F

418

M1.2G